

# Jali

*Terracotta 3D*



**3 Colours / 1 Finish / 1 Size**

Composed of perforated rocks, Jali is a range inspired by Indian architecture. A functional terracotta brick in a delicate shape, conceived to build structures and decorative furnishings, Jali can be used in residential and commercial spaces, indoors and outdoors.

**Design** Patricia Urquiola

**Mutina**





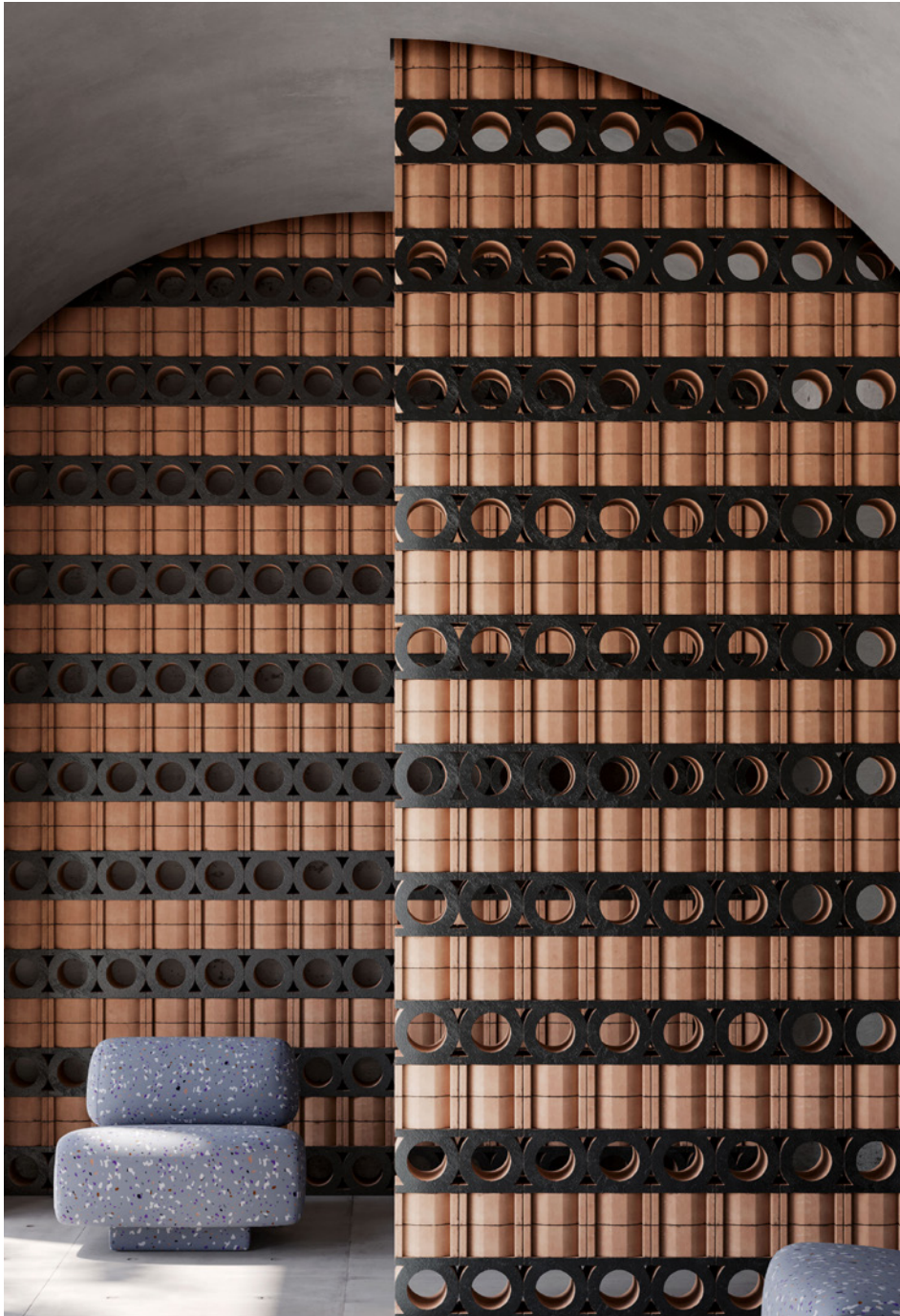

Wall: DMJA 01 & 03 Natural

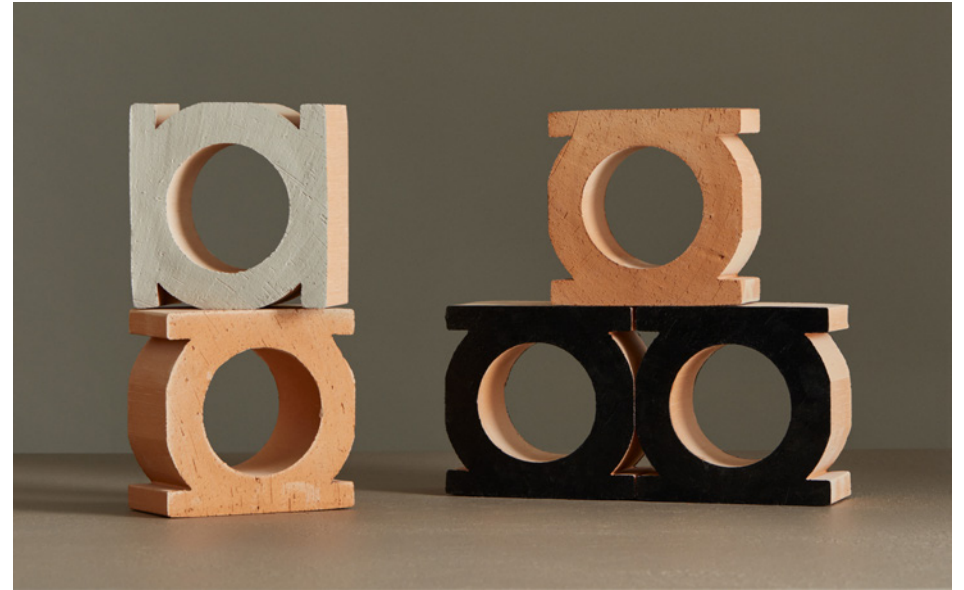

DMJA 01, 02 & 03 Natural



DMJA 01

Natural



DMJA 02

Natural



DMJA 03

Natural

## Sizes

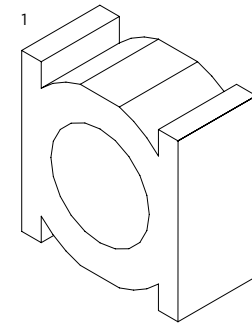

	Size (mm)	Thickness	Finish	Colour Availability
1	234 x 234 (N)	117	Natural	All colours

(N) Nominal size – pressed edge. Swatch colours may vary from original. Samples should be requested. Due to Jali being an artisanal product, a tolerance of 1-3mm is expected. Jali is suitable for use on indoor and outdoor walls with a maximum height of 4m.

# Layout Options

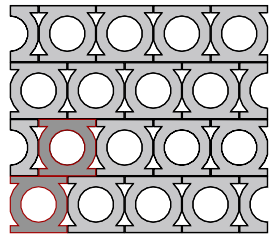

Laying Scheme 1  
17.36 pieces per sqm

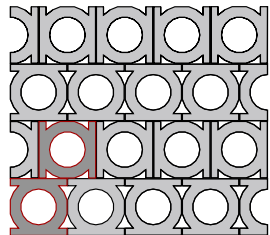

Laying Scheme 2  
17.36 pieces per sqm

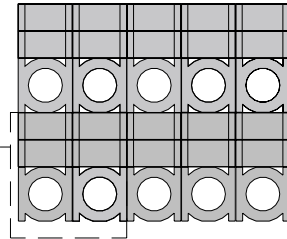
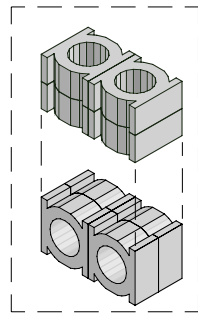

Laying Scheme 3  
34.72 pieces per sqm

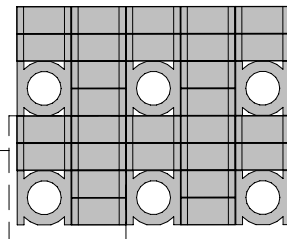
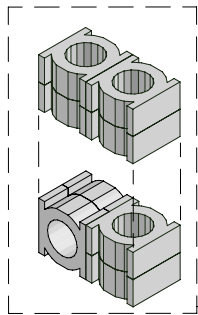

Laying Scheme 4  
34.72 pieces per sqm

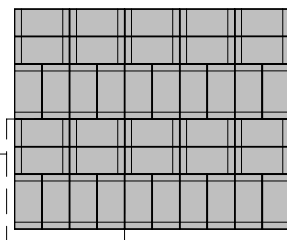
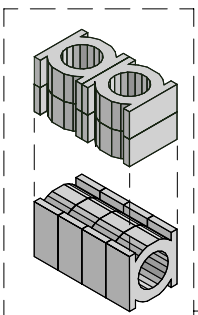

Laying Scheme 5  
34.72 pieces per sqm

# Special Pieces

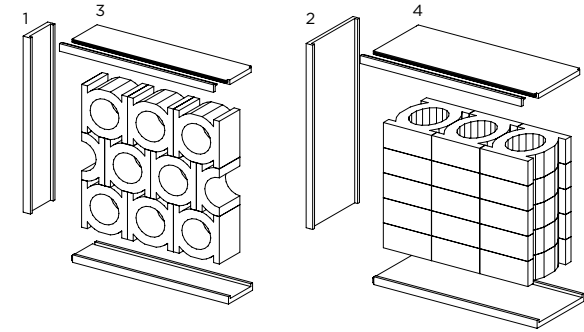

	Size (mm)	Thickness	Finish	Colour Availability
1	Linear Profile 300 x 142	40	Natural	All colours
2	Linear Profile 300 x 259	40	Natural	All colours
3	Terminal Profile 300 x 142	40	Natural	All colours
4	Terminal Profile 300 x 259	40	Natural	All colours

Swatch colours may vary from original. Samples should be requested. Due to Jali being an artisanal product, a tolerance of 1-3mm is expected.