

# Domus Wood Chevron

*Engineered Wood*



Floor: WDOP 015 Chevron 45° Matt UV Lacquer

**24 Colours / 4 Finishes / 2 Sizes**

Domus Wood Chevron is an exclusive and premium range of Engineered Wood from Domus, in two chevron sizes. Incorporates a 4mm European oak surface layer and a HDF core base, each harvested from responsibly managed forests with FSC® mix accreditation.



Floor: WDOP 005 Chevron 22.5° Matt UV Lacquer



Floor: WDOP 034 Chevron 22.5° Matt UV Lacquer



Floor: WDOP 021 Chevron 45° Matt UV Lacquer

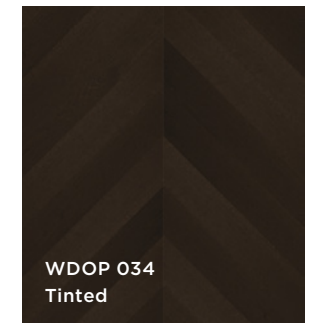
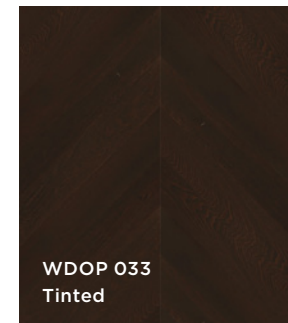
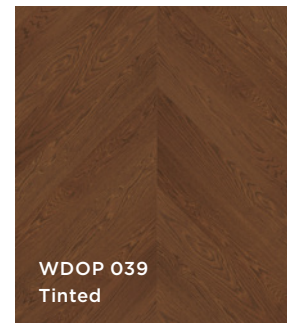
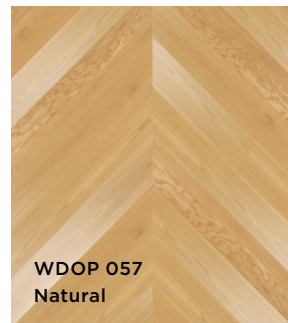
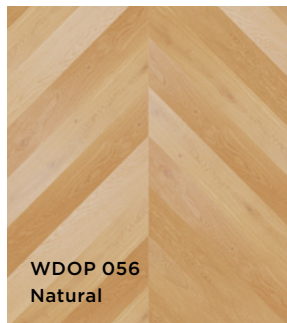
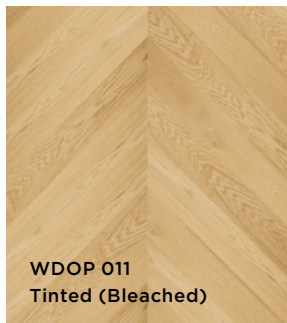
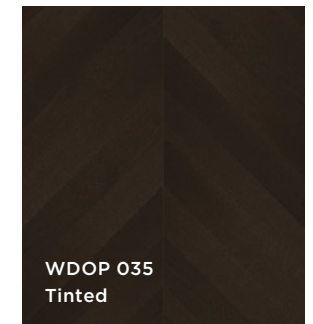
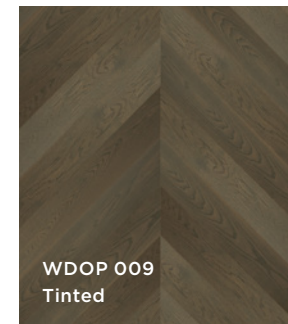
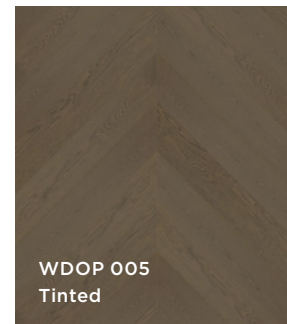
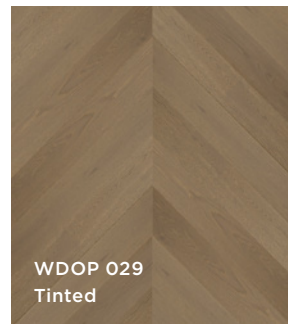
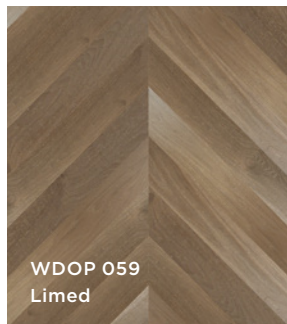
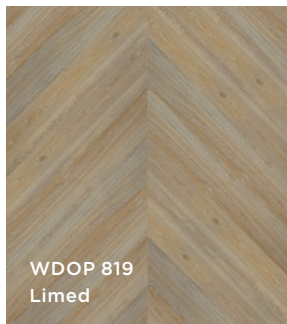
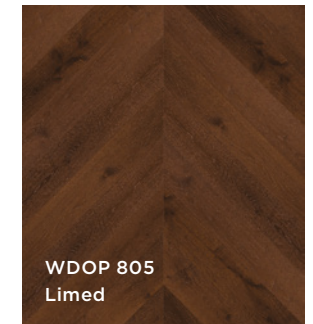
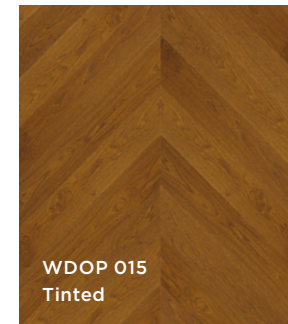
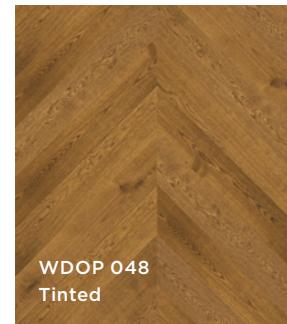
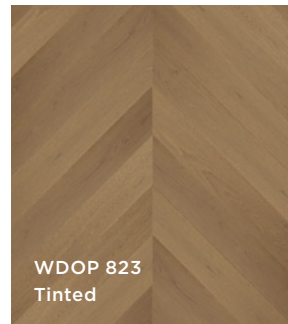
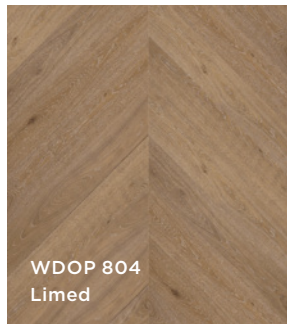
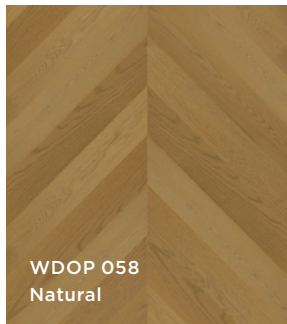
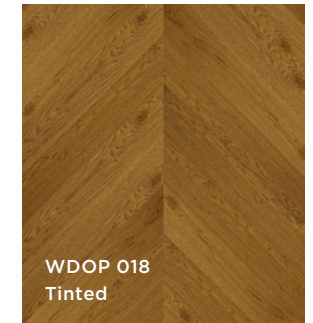
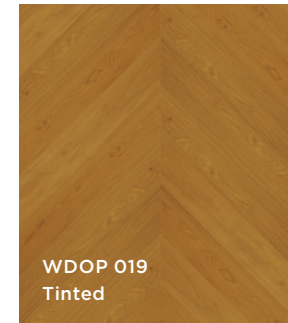
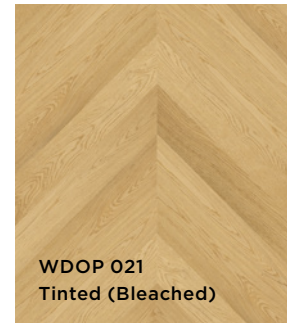
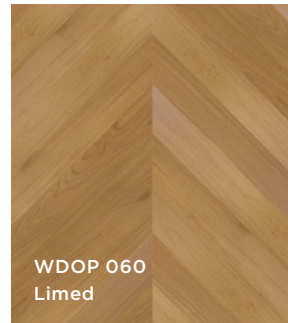
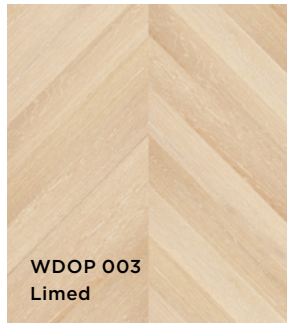
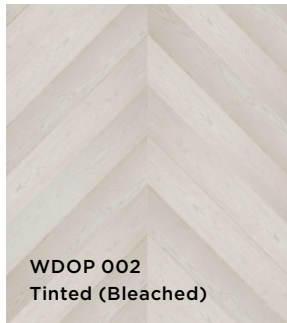

Colours shown in Chevron 45° layout.

Colours shown in Chevron 45° layout.

# Product Data

Engineered Wood

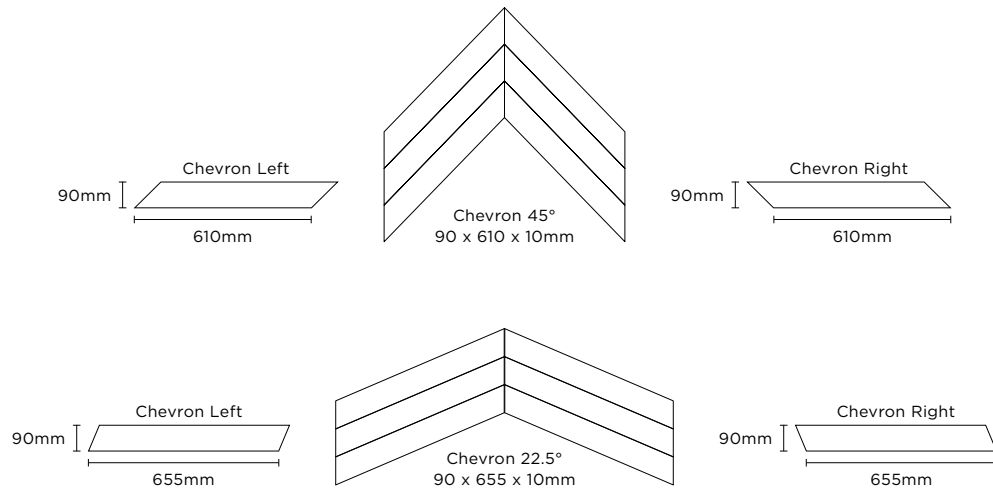

## Specification

**Material:** European Oak (*Quercus robur*)      **Finishes:** Wax, Matt UV Lacquer (WDOP 056-058)  
**Grade:** Select      Natural Oiled Matt (WDOP 019)  
**Brushing:** D-Brushed      Water-Based Matt Lacquer (WDOP 035)  
**Certification:** FSC\* Mix      Matt UV Lacquer (all other colours)

**Construction:** 10mm (6mm HDF core base and 4mm oak surface layer).

4-way micro bevel. Tongue & groove all 4 sides.

**Application:** Internal use only. Suitable with underfloor heating.

**Installation:** Recommended to be fully bonded.

**Treatment:** Tinted (WDOP 005, 009, 015, 018, 019, 029, 033-035, 039, 048 & 823)  
 Tinted Bleached (WDOP 002, 011 & 021)  
 Limed (WDOP 003, 059, 060, 804, 805 & 819)  
 Natural (WDOP 056-058)

**DOMUS**  
WOOD

service@domuswood.com | t: 020 8481 9500 | domuswood.com

# Technical Data

Engineered Wood

Cleaning & Maintenance Specification:

**ETC&M 03 (WDOP 019)**  
**ETC&M 01 (all other colours)**

## PERFORMANCE & DURABILITY

Technical Characteristics	Industry Standard	Performance
Wood Species		Oak ( <i>Quercus robur</i> )
Origin		Europe (FSC® 100%)
Reaction to Fire	UNI EN 14342 EN 13501-1	Dfl-S1
Formaldehyde Emission	UNI EN 14342 EN 717-1	E1 = 0.124mg/m³ air
Pentachlorophenol Emission	UNI EN 14342 CEN/TR 14823	< 5ppm
Thermal Conductivity	UNI EN 14342 EN ISO 10456-2007	0.10W/mK

NB: Compatible with underfloor heating systems - subject to K21 installation advice available on request.

All test results are based upon current test data provided by the manufacturer and are provided in good faith. Domus Group Limited cannot be held responsible for any variation in the test data due to changes in manufacture or material characteristics. Errors & omissions excepted. Please refer to Domus Group Limited Terms & Conditions of Sale, 27 October 2023

## Construction



The mark of  
responsible forestry  
FSC® C124301

