

# I Colori Matt

*Ceramic Colours*



**40 Colours / 1 Finish / 12 Sizes / 4 Mosaics**

I Colori Matt is a colourful range of frost-proof ceramic tiles suitable for indoor and outdoor use. I Colori Matt is available in modular sizes and can be combined with I Colori Lucido, I Colori Full Body and I Colori Anti-Slip.



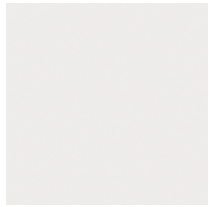

DCORM 01



DCORM 02



DCORM 03



DCORM 04



DCORM 21



DCORM 22



DCORM 23



DCORM 24



DCORM 07



DCORM 08



DCORM 05



DCORM 06



DCORM 25



DCORM 26



DCORM 27



DCORM 28



DCORM 12



DCORM 09



DCORM 10



DCORM 11



DCORM 29



DCORM 30



DCORM 31



DCORM 32



DCORM 13



DCORM 14



DCORM 15



DCORM 16



DCORM 33



DCORM 34



DCORM 35



DCORM 36



DCORM 17



DCORM 18



DCORM 19

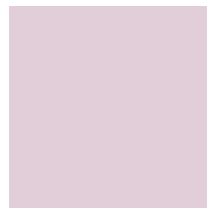

DCORM 20



DCORM 37



DCORM 38



DCORM 39



DCORM 40



Wall: DCORM 01, 08, 11, 12, 14, 18, 19, 20, 22, 24, 25, 27, 28, 37 & 39 Matt

## Sizes

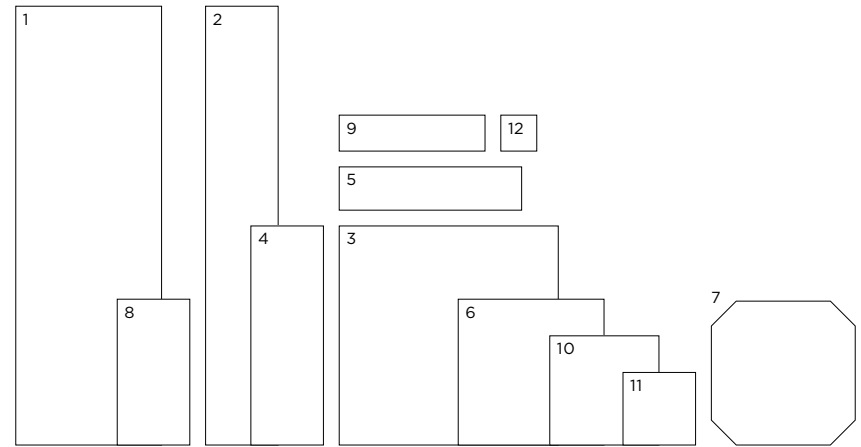

	Size (mm)	Thickness	Finish	Colour Availability
1	600 x 200 (N)	8	Matt	DCORM 01-04, 06-08, 10, 14, 18, 24, 27, 28, 34, 35 & 38
2	600 x 100 (N)	8	Matt	DCORM 01-04, 06-08, 10, 14, 18, 24, 27, 28, 34, 35 & 38
3	300 x 300 (N)	8	Matt	DCORM 01, 02, 05, 06 & 07
4	300 x 100 (N)	8	Matt	DCORM 01-04, 06-08, 10, 14, 18, 24, 27, 28, 34, 35 & 38
5	250 x 60 (N)	6.5	Matt	DCORM 01-03, 05-07, 10, 14, 16, 19-21, 24, 27, 28 & 33-37
6	200 x 200 (N)	6.5	Matt	All colours
7	Octagon 200 x 200 (N)	5.5	Matt	DCORM 01, 02, 05, 06 & 07
8	200 x 100 (N)	6.5	Matt	DCORM 01, 02, 03, 06 & 07
9	200 x 50 (N)	6.5	Matt	All colours
10	150 x 150 (N)	6.5	Matt	DCORM 01, 02, 03, 06 & 07
11	100 x 100 (N)	6.5	Matt	All colours
12	50 x 50 (N)	5.5	Matt	All colours

(N) Nominal size - pressed edge. Swatch colours may vary from original. Samples should be requested. Mosaics shown on next page.

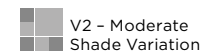

V2 - Moderate  
Shade Variation

**DOMUS**

service@domusgroup.com | t: 020 8481 9500 | domusgroup.com

Mosaic 100 x 30mm



DCORM 01

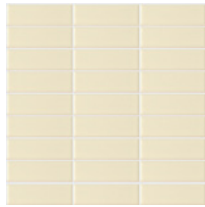

DCORM 07

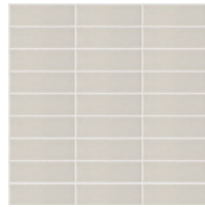

DCORM 02

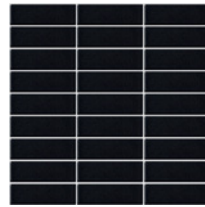

DCORM 06

Mosaic 50 x 50mm

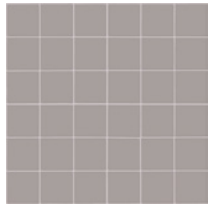

DCORM 03

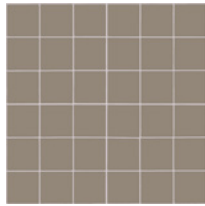

DCORM 10

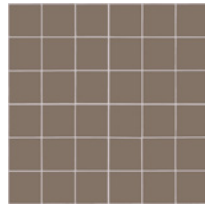

DCORM 04

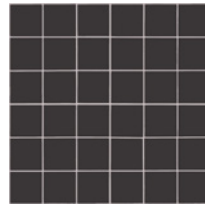

DCORM 05

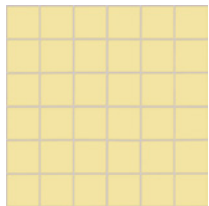

DCORM 12

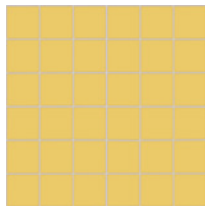

DCORM 13

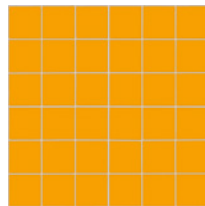

DCORM 14

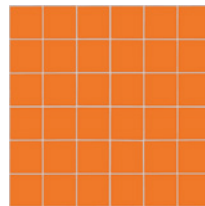

DCORM 15

Mosaic 25 x 25mm

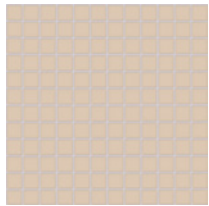

DCORM 08

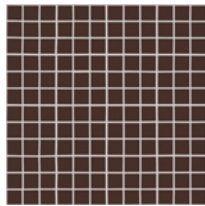

DCORM 11

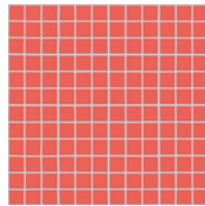

DCORM 17

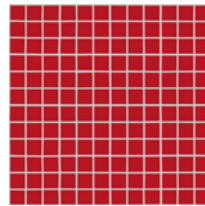

DCORM 18

Mosaic 100 x 100mm

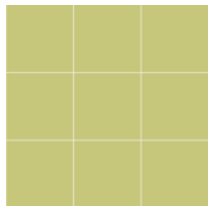

DCORM 38

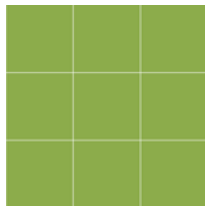

DCORM 39

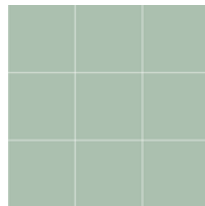

DCORM 35

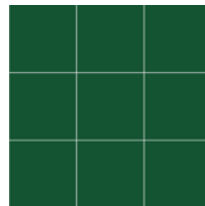

DCORM 37

# Mosaics

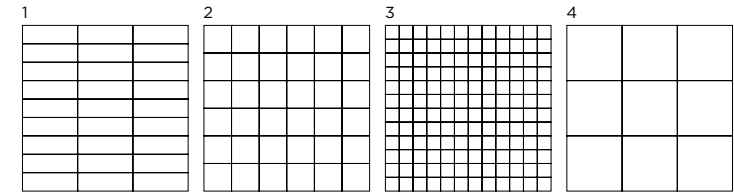

	Size (mm)	Thickness	Finish	Colour Availability
1	Mosaic 100 x 30 (N) on 300 x 300 sheet	5.5	Matt	DCORM 01, 02, 06 & 07
2	Mosaic 50 x 50 (N) on 300 x 300 sheet	5.5	Matt	All colours
3	Mosaic 25 x 25 (N) on 300 x 300 sheet	5.5	Matt	All colours
4	Mosaic 100 x 100 (N) on 300 x 300 sheet	6.5	Matt	All colours

(N) Nominal size – pressed edge. Swatch colours may vary from original. Samples should be requested.

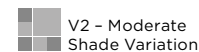

# Special Pieces

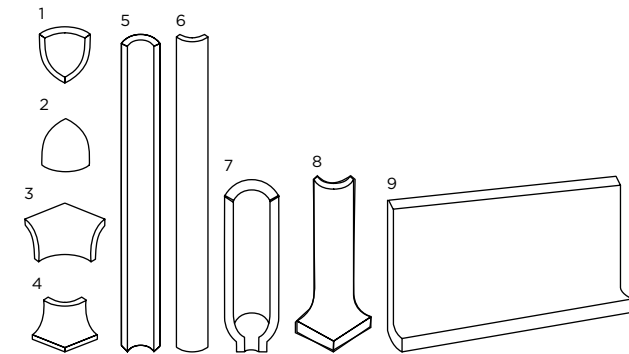
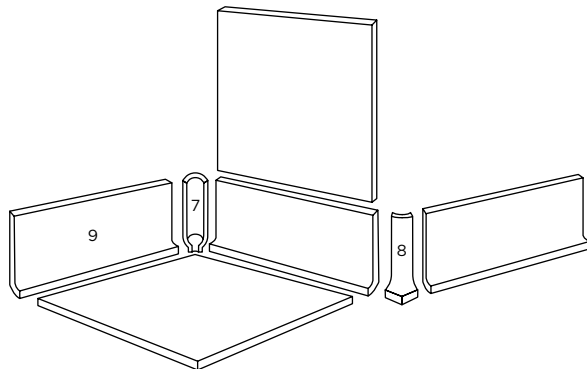
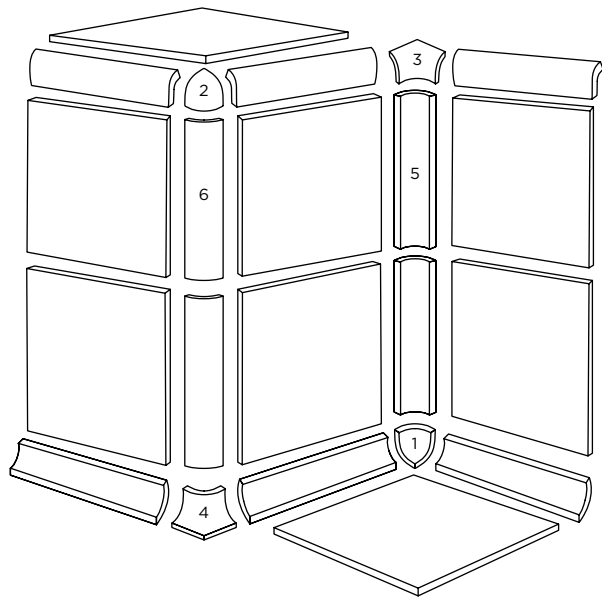

	Size (mm)	Finish	Colour Availability
1	Internal Shell 25 x 25	Matt	All colours
2	External Shell 25 x 25	Matt	All colours
3	Internal Footplate 25 x 25	Matt	All colours
4	External Footplate 25 x 25	Matt	All colours
5	Internal Channel 200 x 25	Matt	All colours
6	External Channel 200 x 25	Matt	All colours
7	Internal Corner 100 x 25	Matt	All colours
8	External Corner 100 x 25	Matt	All colours
9	Cove Base 200 x 100	Matt	All colours

(N) Nominal size - pressed edge. Swatch colours may vary from original. Samples should be requested.



# I Colori Matt

## Technical Data

**Product Type:** Glazed Ceramic (BS EN 14411 – Group B1b)

**Use:** Floors & Walls

**Product Code:** DCORM

### DIMENSION & SURFACE QUALITY

Technical Characteristics	Industry Standards	Requirement	Actual Value
Length & width	BS EN ISO 10545-2	± 0.60% (max. ± 2.0mm)	Conforms
Thickness	BS EN ISO 10545-2	± 5% (max. ± 0.5mm)	Conforms
Edge straightness	BS EN ISO 10545-2	± 0.50% (max. ± 1.5mm)	Conforms
Orthogonality (squareness)	BS EN ISO 10545-2	± 0.50% (max. ± 2.0mm)	Conforms
Planarity (flatness)	BS EN ISO 10545-2	± 0.50% (max. ± 2.0mm)	Conforms

### SLIP RESISTANCE

Technical Characteristics	Industry Standards	Requirement	Finish
Slip resistance	BS 7976-2	Test results upon request	
Coefficient of friction	BS EN 16165		

### PRODUCT QUALITY & DURABILITY

Technical Characteristics	Industry Standards	Requirement	Actual Value
Water absorption	BS EN ISO 10545-3	0.5% < Eb ≤ 3%	Conforms
Modulus of rupture (bending strength)	BS EN ISO 10545-4	≥ 30 N/mm <sup>2</sup>	Conforms
Resistance to surface abrasion (glazed tiles)	BS EN ISO 10545-7	PEI *see classifications below	Class 2 – DCORM 04, 06, 09, 10, 11, 15, 16, 17, 18, 19, 22, 23, 24, 25, 29 Class 3 – DCORM 03, 05, 13, 14, 21, 26, 27, 28, 31, 33, 36, 37, 38, 39, 40 Class 4 – DCORM 01, 02, 07, 08, 12, 20, 30, 32, 34, 35
Linear thermal expansion coefficient	BS EN ISO 10545-8	Declared value	5x5x10 <sup>-6</sup> K <sup>-1</sup> (Typical value)
Thermal shock resistance	BS EN ISO 10545-9	No visible defects	Resistant
Crazing resistance	BS EN ISO 10545-11	No visible signs	Resistant
Frost resistance	BS EN ISO 10545-12	No surface alteration	Resistant
Chemical resistance: Low concentrations of acids & alkalis	BS EN ISO 10545-13	No visible defects	GLA
High concentrations of acids & alkalis	BS EN ISO 10545-13	No visible defects	GHA
Domestic chemicals & additives for swimming pools	BS EN ISO 10545-13	UB/GB min.	GA
Stain resistance	BS EN ISO 10545-14	Min. Class 3 – glazed	Class 3
Reaction to fire	Based on the decision 96/603/EC and its changes	A1 <sub>FL</sub> /A1	A1 <sub>FL</sub> /A1

#### \*PEI classifications

- PEI 1 - Very light traffic
- PEI 2 - Light traffic
- PEI 3 - Light to moderate traffic
- PEI 4 - Moderate to heavy traffic
- PEI 5 - Heavy to extra heavy traffic



All test results are based upon current test data provided by the manufacturer and are provided in good faith. Domus Group cannot be held responsible for any variation in the test data due to changes in manufacture or material characteristics. Errors & omissions excepted. Please refer to Domus Group Terms & Conditions of Sale. December 2022

**DOMUS**

service@domusgroup.com | t: 020 8481 9500 | domusgroup.com